

Halfpipe Trailer



rolly toys Kundendienst Deutschland:

Tel: +49 (0) 95 68 / 856-142

Fax: +49 (0) 95 68 / 856-183

e-mail: service@rollytoys.de

2016/12

217.000.800.00

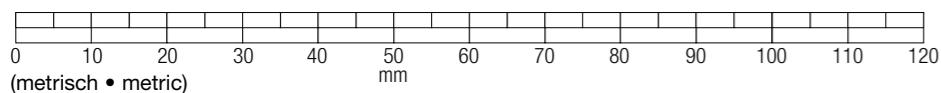
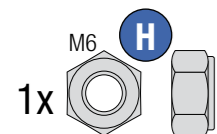
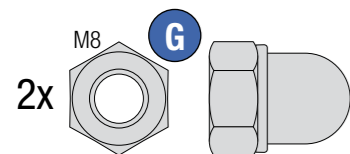
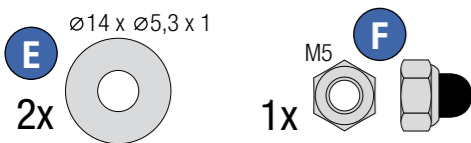
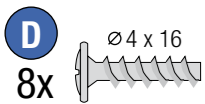
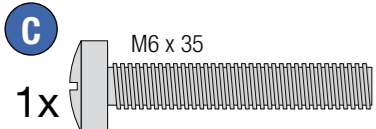
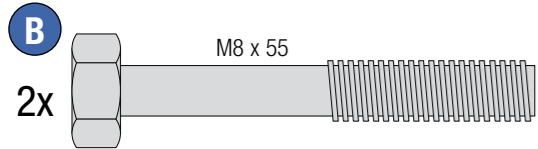
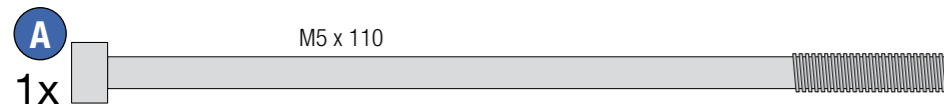

---NORTH & SOUTH AMERICA only---

180 days warranty

From the date of purchase + guaranteed spare part service
The warranty does not cover damages caused by improper use or neglect



WARNING

- CHOKING HAZARD - Small parts, Danger of being swallowed. Contains small parts in non assembled state. Must be assembled by adults.
- Toy is not suitable to carry children.
- If toy is defective stop using it, repairs may only be carried out by adults.
- Adult supervision required.
- Never use near steps, slopes, driveways, hills, roadways, alleys or swimming pool areas.
- Always wear shoes.
- Conforms to the requirements of ASTM Standard Consumer Safety Specification on Toy Safety, F 963.

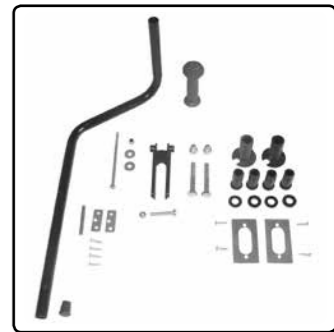
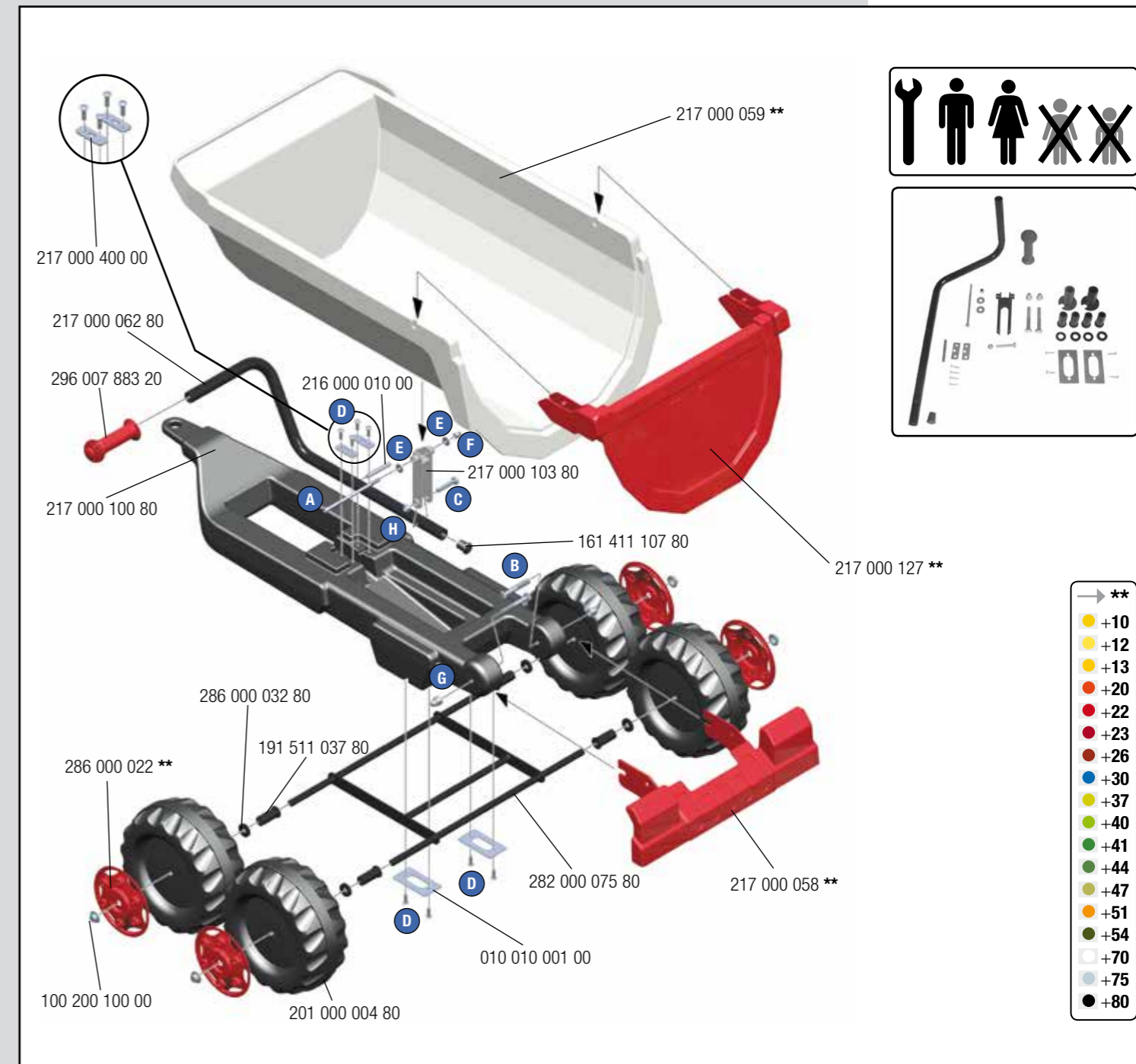

- **
- +10
- +12
- +13
- +20
- +22
- +23
- +26
- +30
- +37
- +40
- +41
- +44
- +47
- +51
- +54
- +70
- +75
- +80

<input type="checkbox"/>	rolly Dreiradtraktoren	05 ●●●
<input type="checkbox"/>	rollyMinitrac	13 ●●●
<input type="checkbox"/>	rollyKid	01 ●●● / 02 ●●●
<input checked="" type="checkbox"/>	rollyJunior	80 ●●● / 81 ●●●
<input checked="" type="checkbox"/>	rollyFarmtrac	60 ●●● / 61 ●●●
<input checked="" type="checkbox"/>	rollyFarmtrac Classic	03 ●●● / 04 ●●●
<input checked="" type="checkbox"/>	rollyFarmtrac Premium	70 ●●● / 71 ●●●
<input checked="" type="checkbox"/>	rollyX-Trac	03 ●●● / 04 ●●●
<input checked="" type="checkbox"/>	rollyTruck (Unimog)	03 ●●●

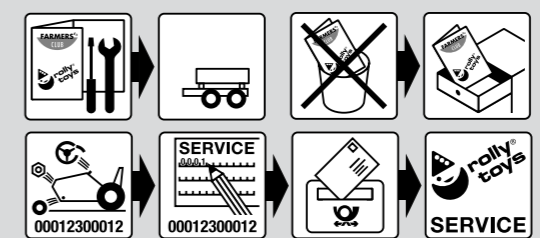

Franz Schneider GmbH & Co KG
P.O.Box 1460
D-96459 - Neustadt bei Coburg - Germany
Tel.: +49 (0) 95 68 / 856-0
Fax.: +49 (0) 95 68 / 856-190
www.rollytoys.com

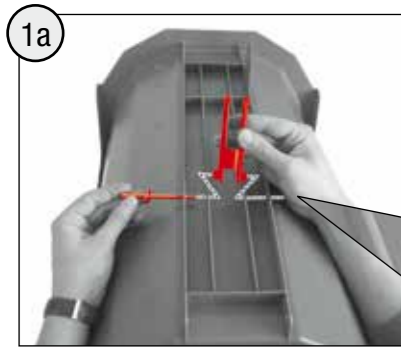

1x **A** M5x110 **E** Ø14 x Ø5,3 x 1

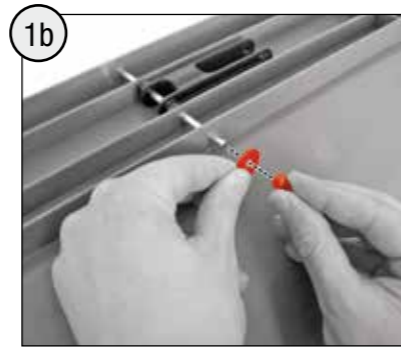

1x **E** Ø14 x Ø5,3 x 1 **F** M5

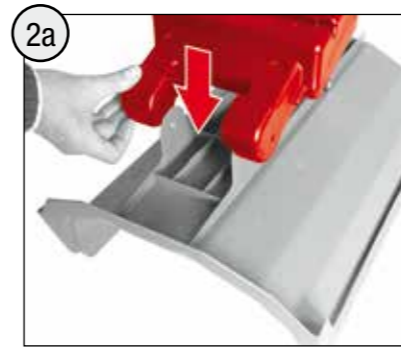
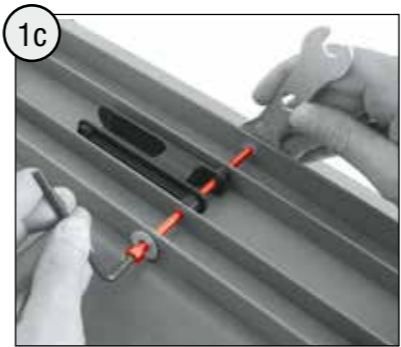

2x **B** M8 x 55

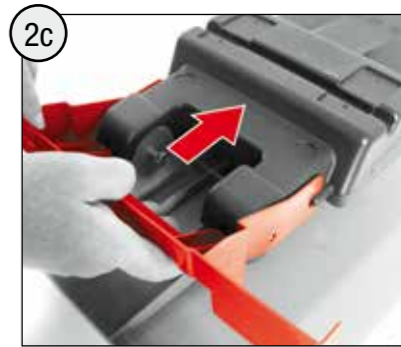

1x

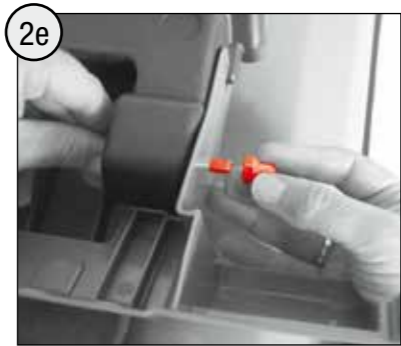
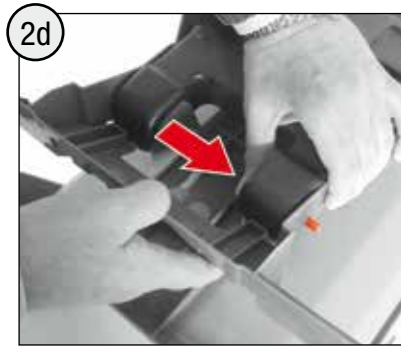

2x **G** M8

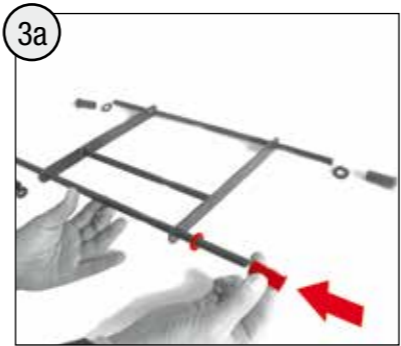
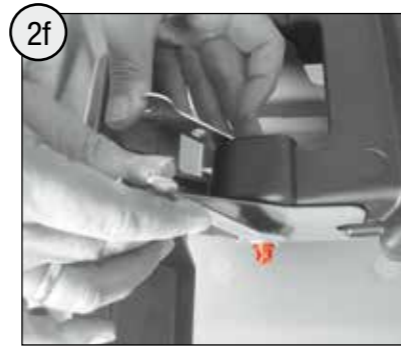

4x

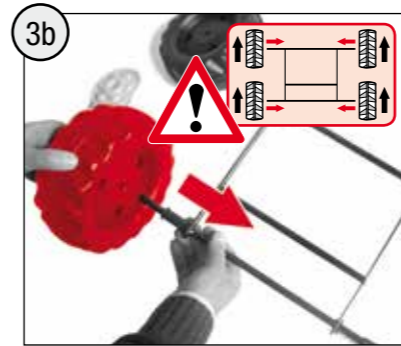

4x



4x



4x

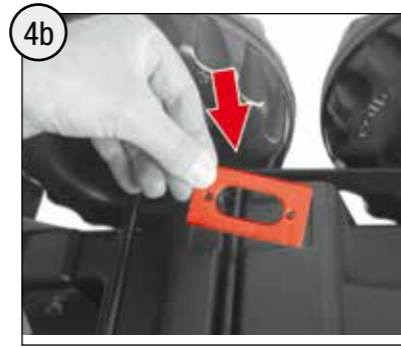
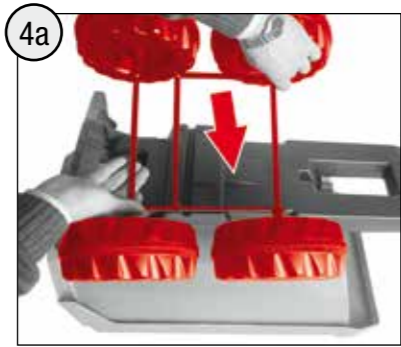

2x



4x **D** Ø4 x 16

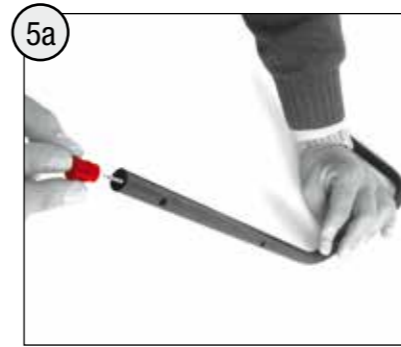

1x



1x

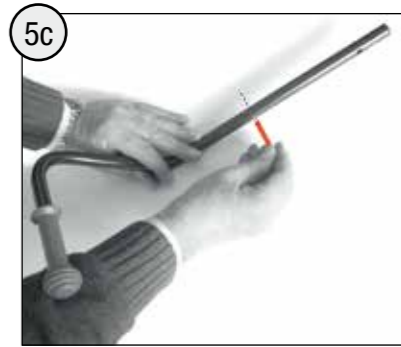

1x Ø6 x 48

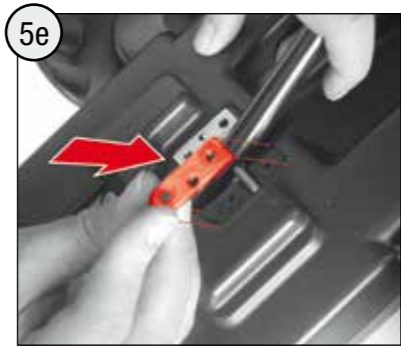
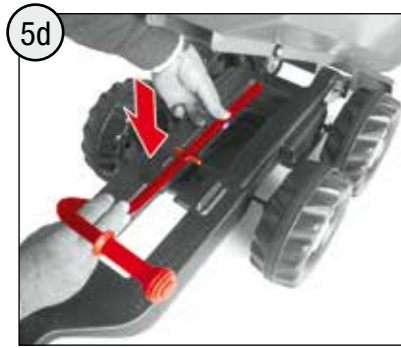

2x

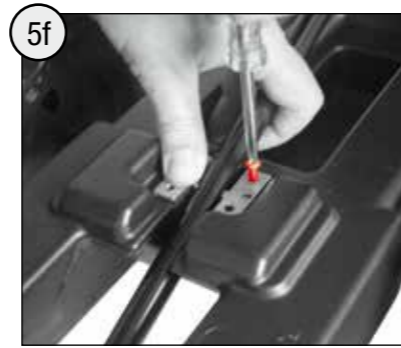

4x **D** Ø4 x 16



1x **C** M6 x 35

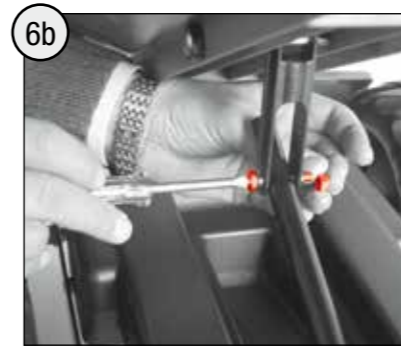

1x **H** M6

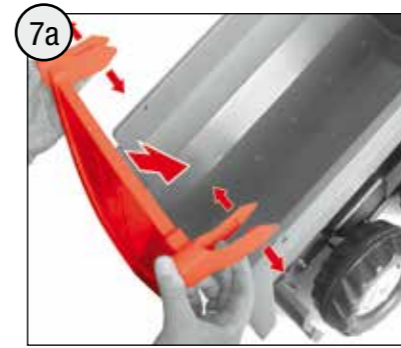

KLACK!